

Ray Tracing in 2D

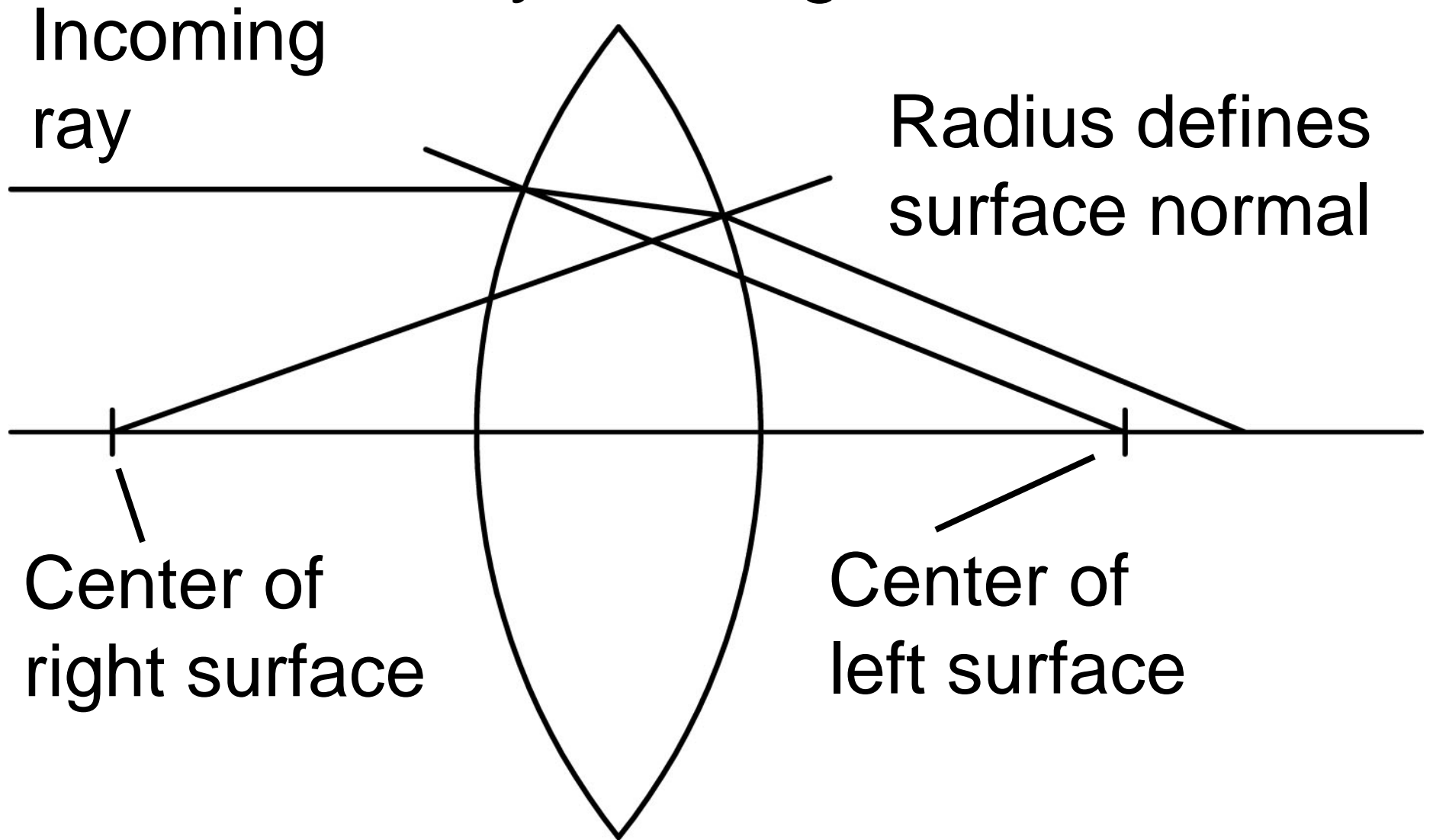

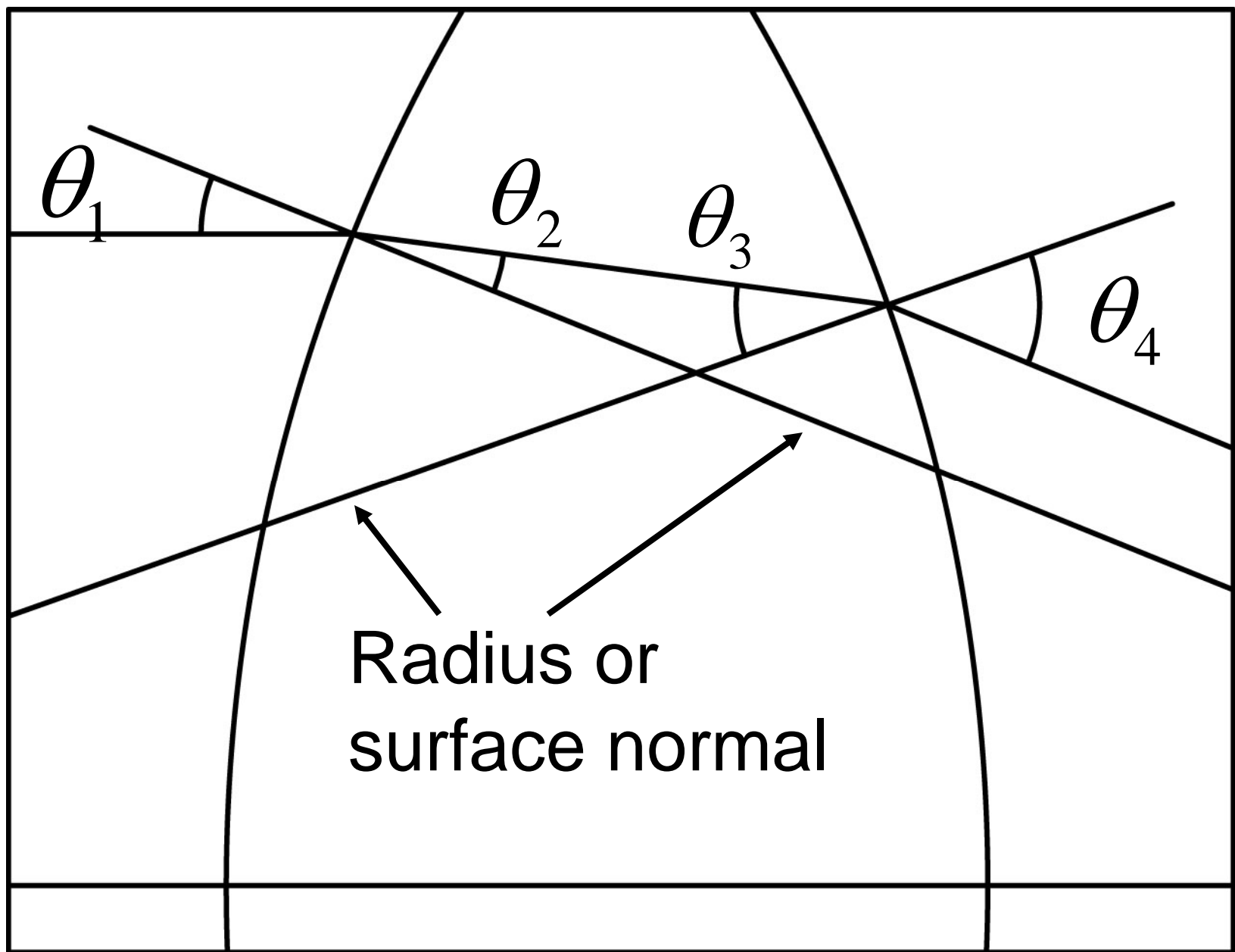

2D Ray Trace

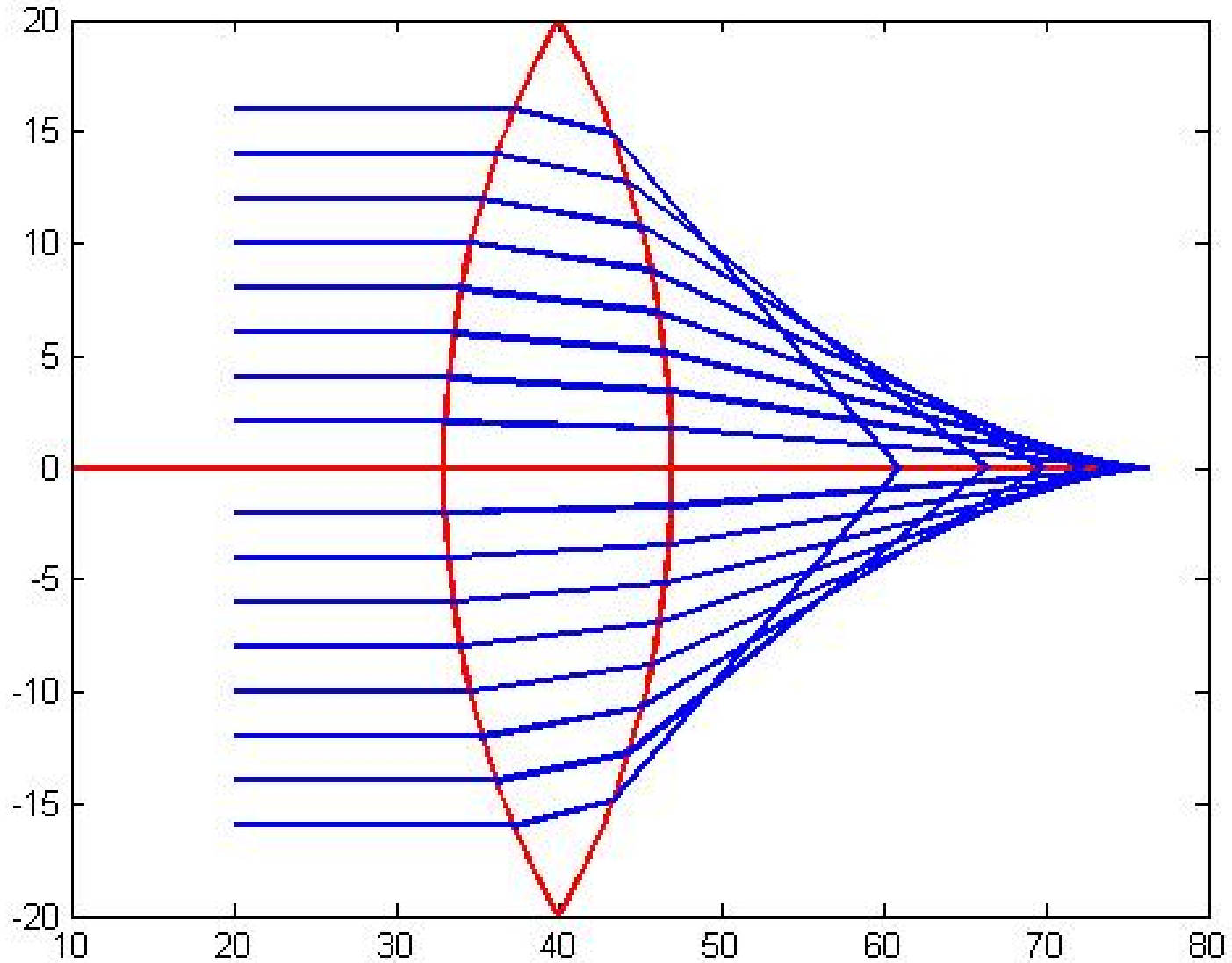

2D Ray Trace

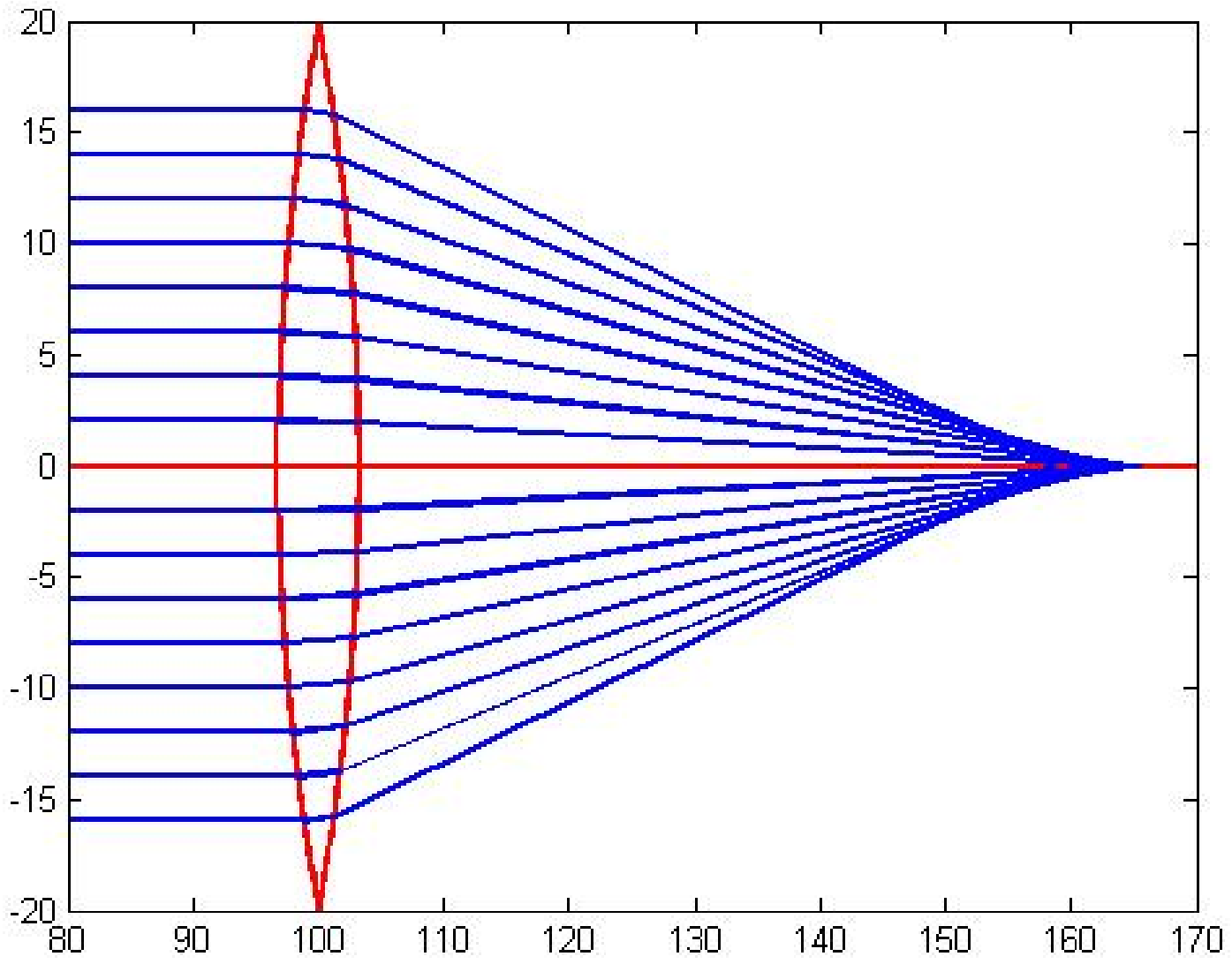

Area CCD Array from Handheld Camera

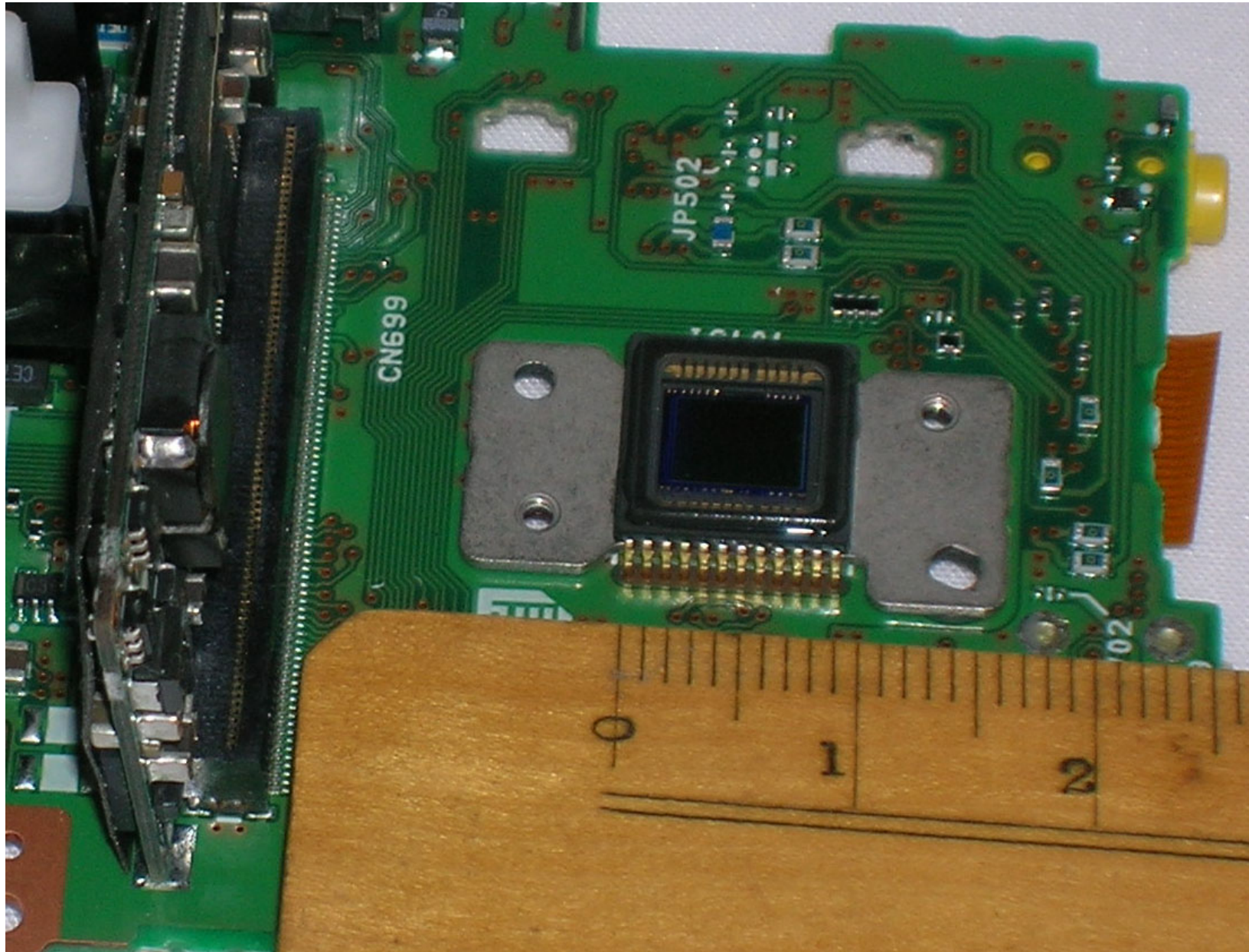

Common CCD Image Sensor Formats

(Dimensions in Millimeters)

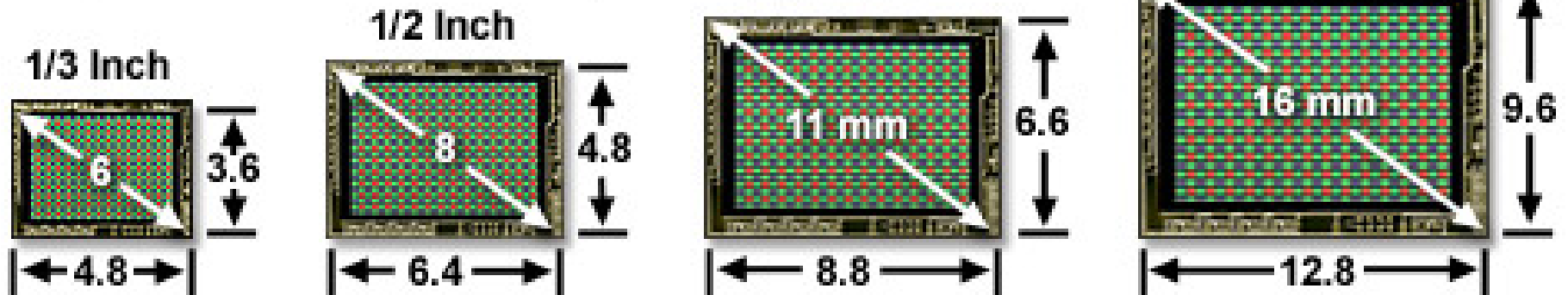

Confusing “inch” size designation of CCD arrays: diagonal is approx. 70% of active area on face of round vidicon tube with the “inch” outside diameter

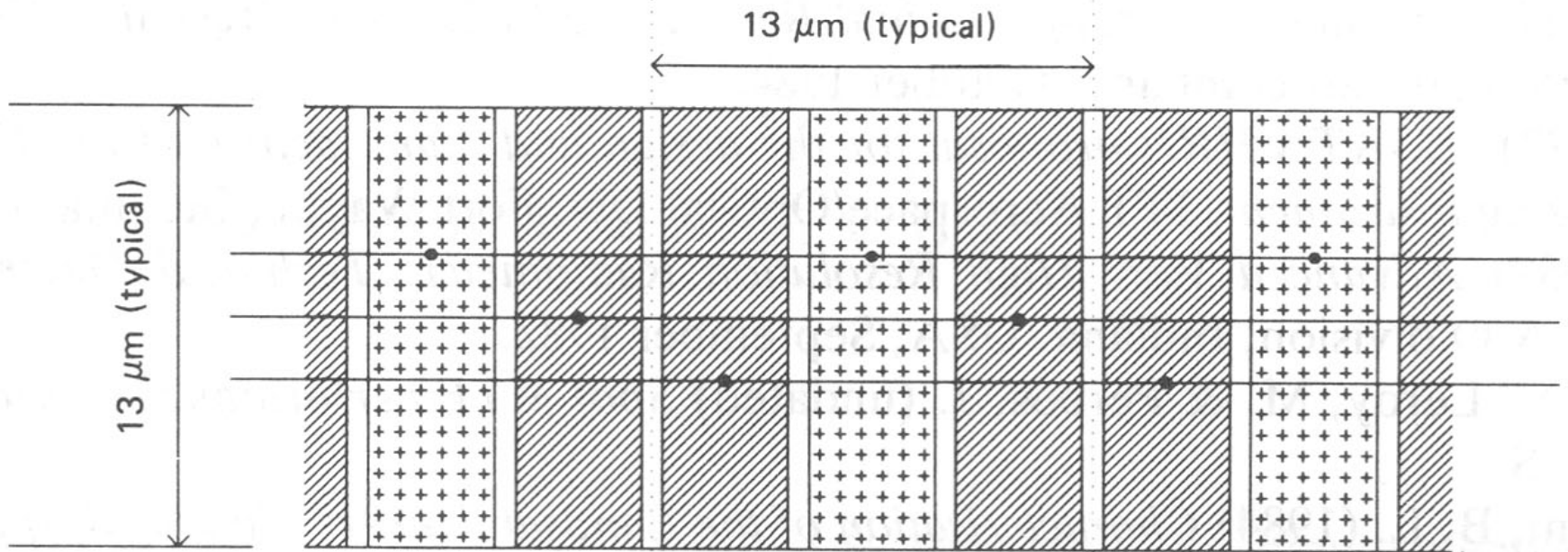
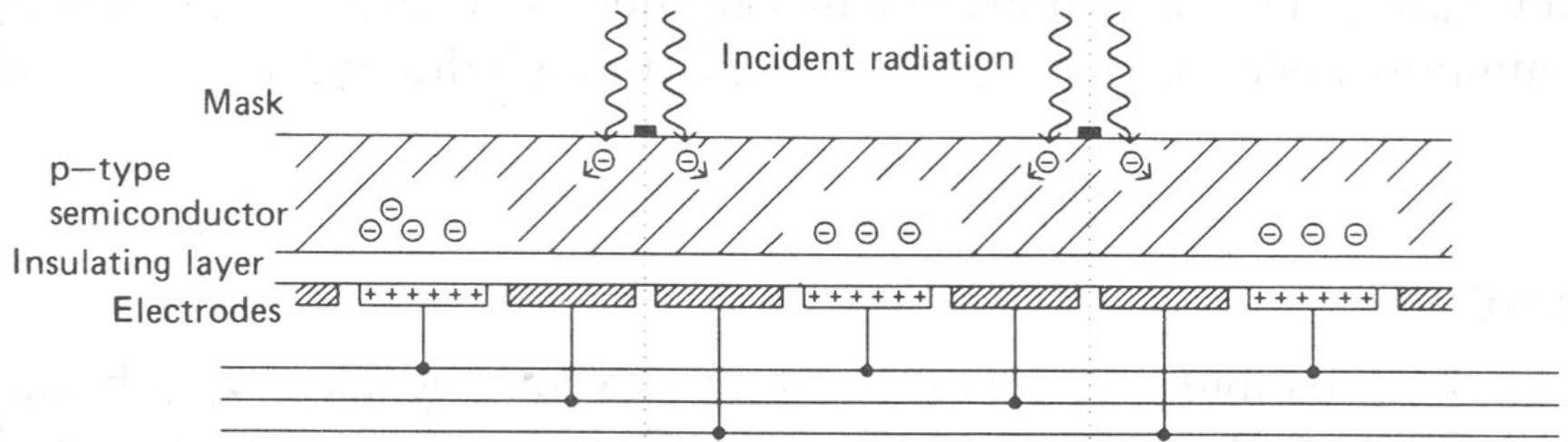

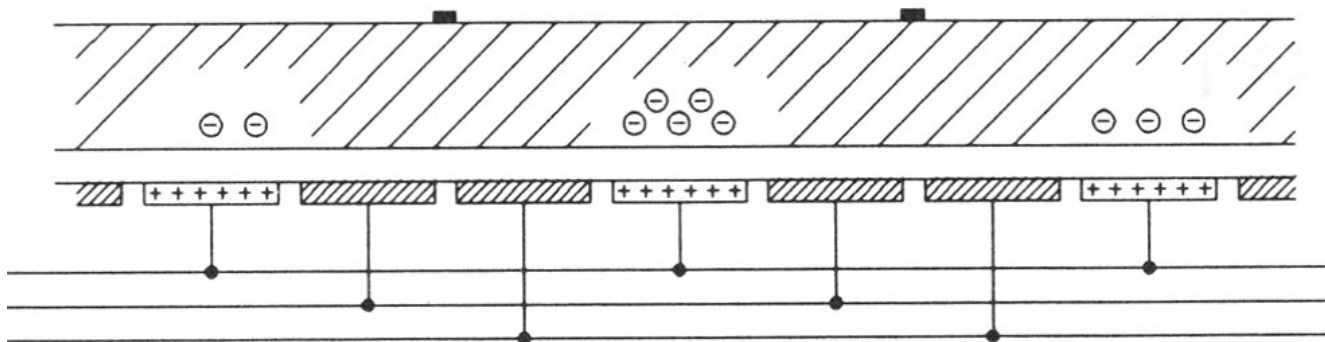
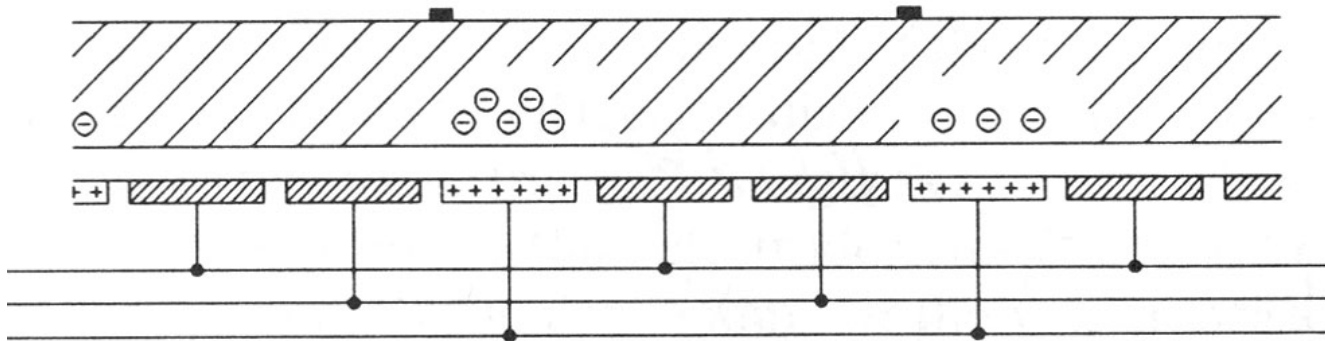
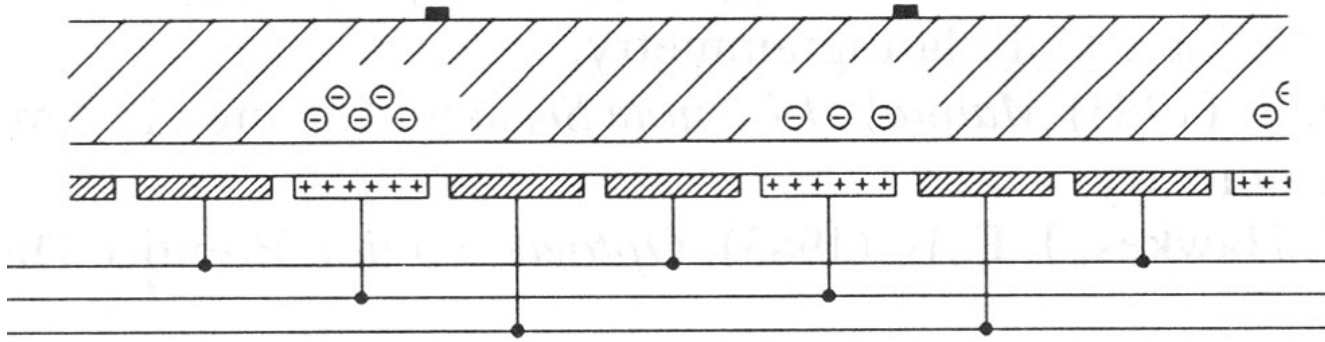

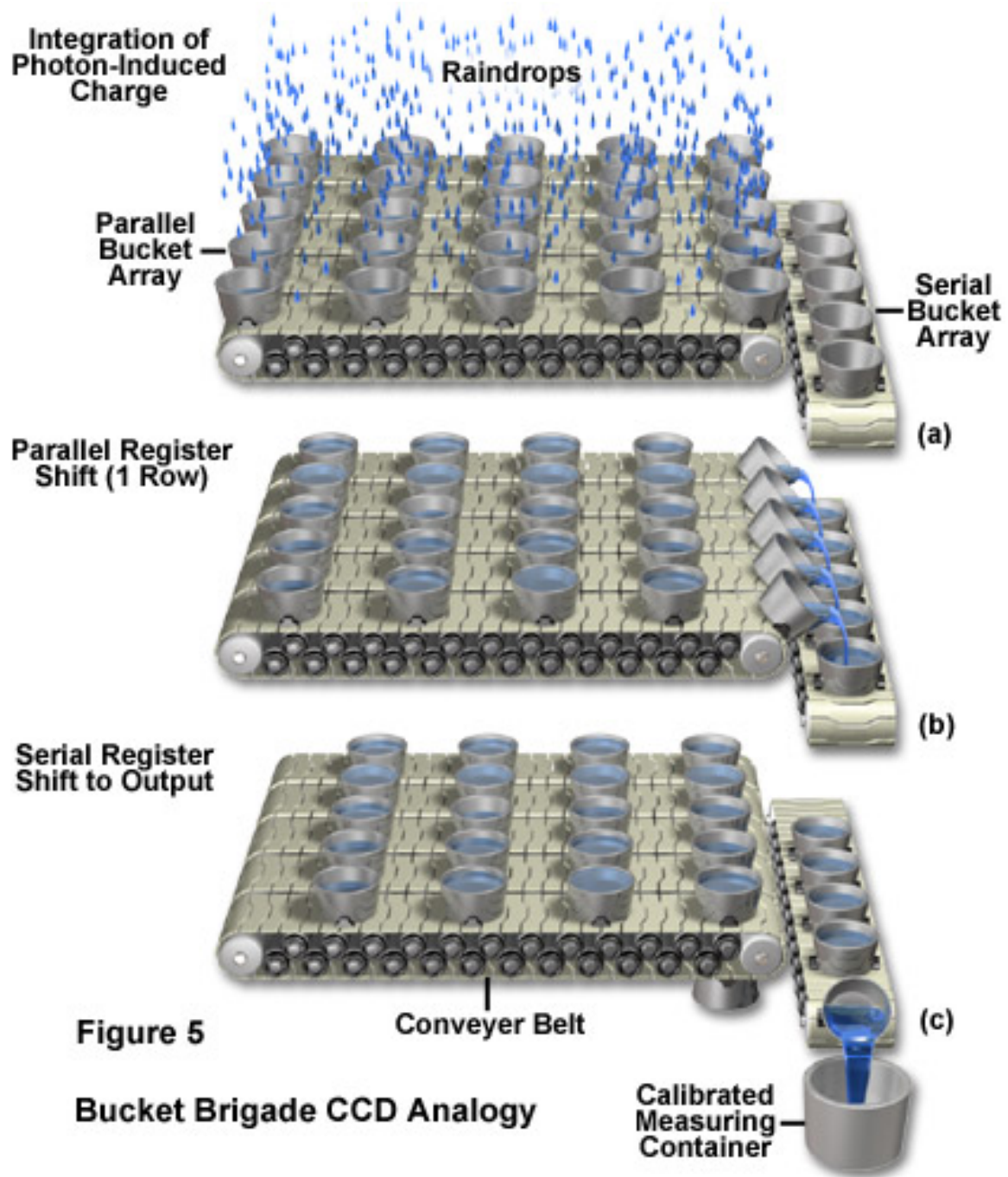
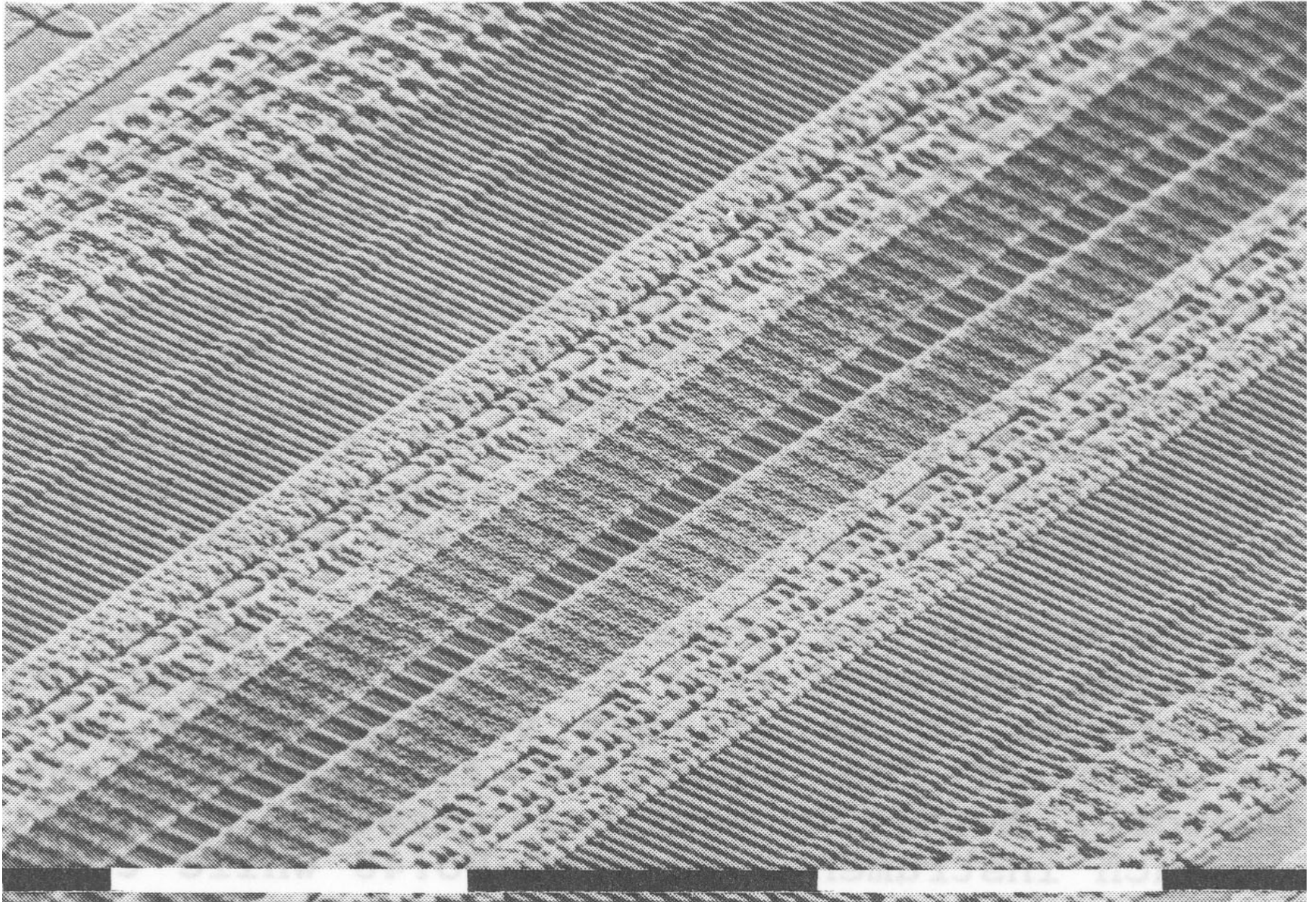

Figure 5

Bucket Brigade CCD Analogy

Linear CCD Array – Scale 100um



Linear CCD Array – Scale 10um

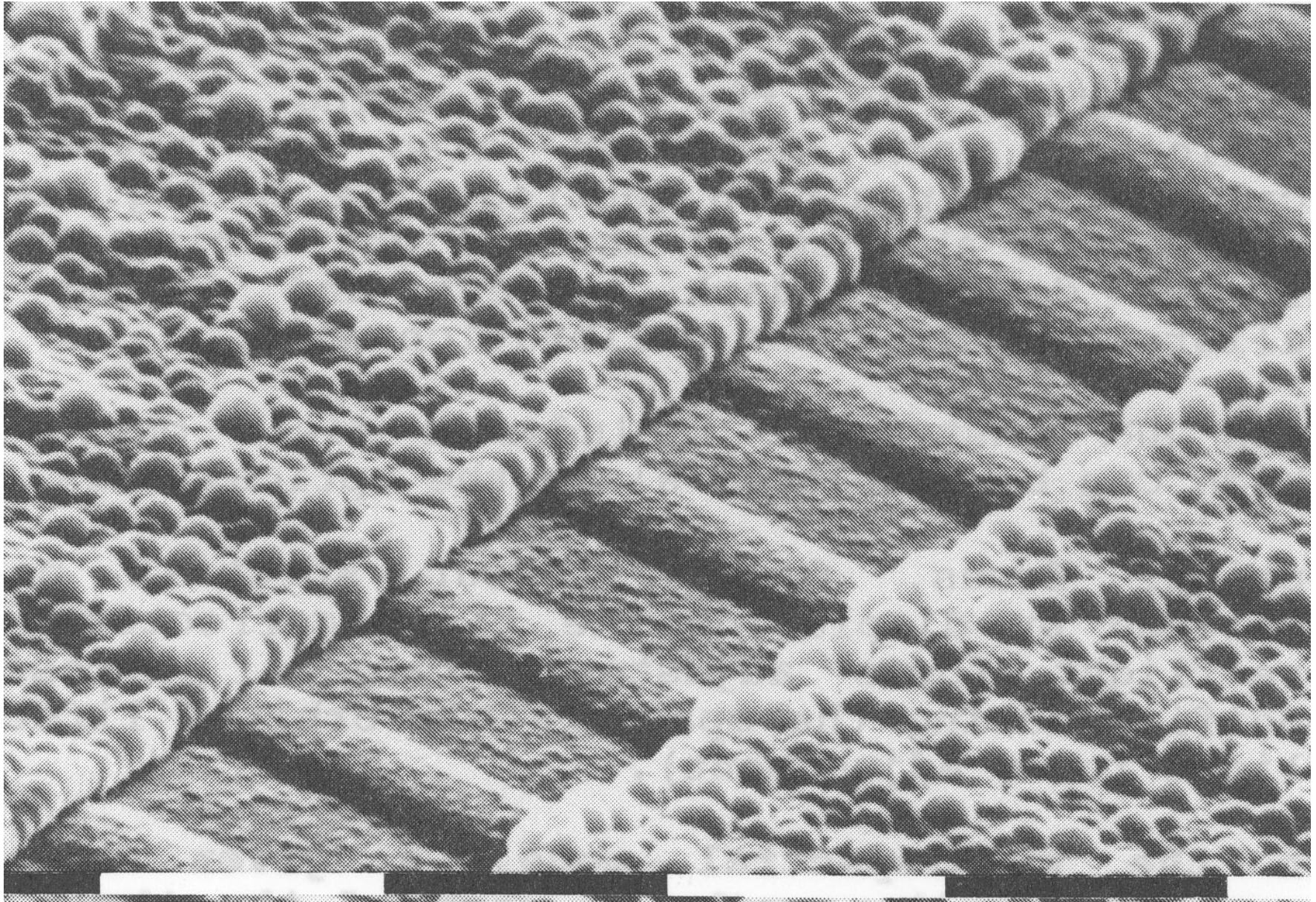

Bayer Filter for Low Cost Color

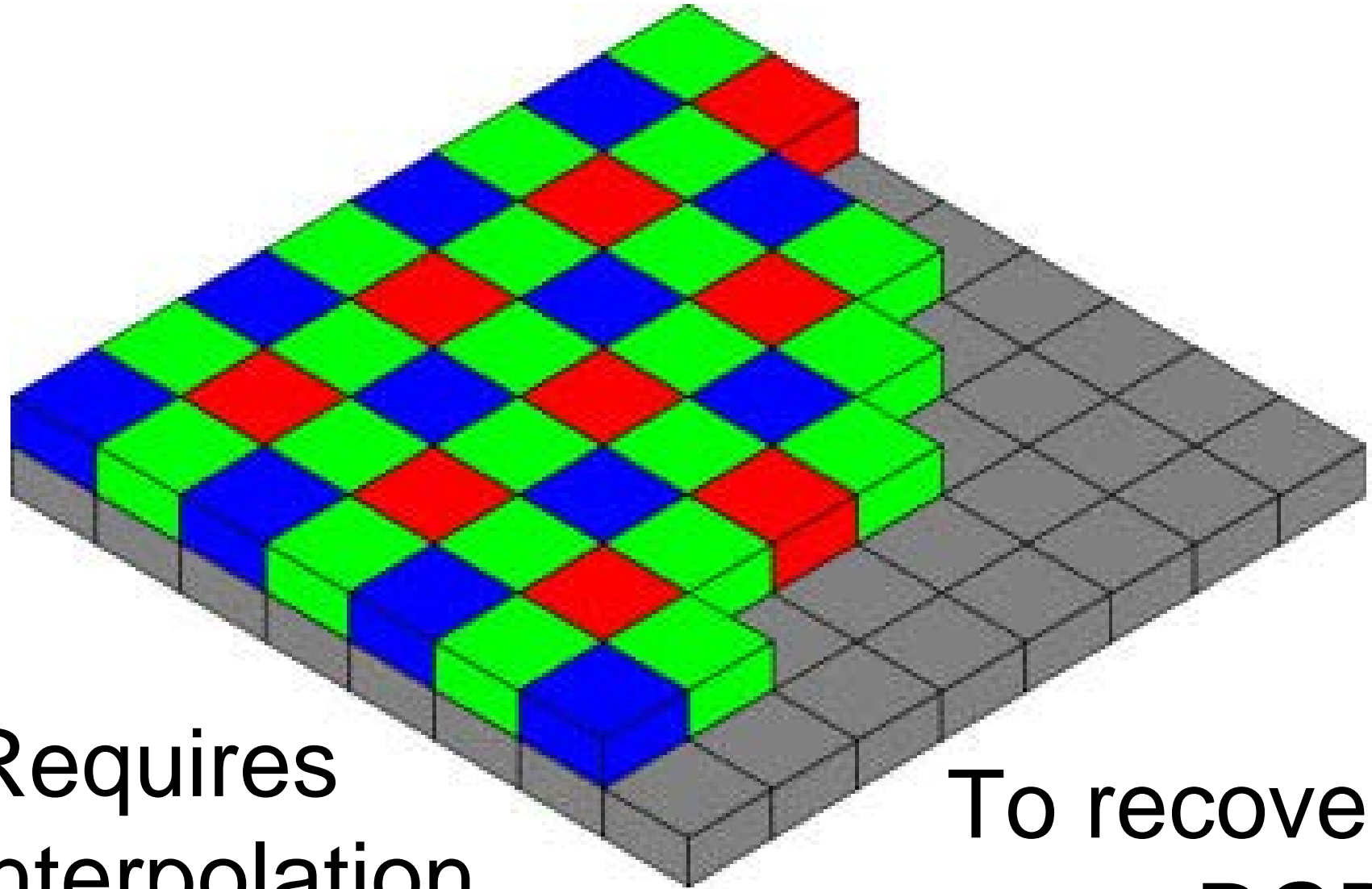

Requires
interpolation

To recover
RGB

Bayer Filter

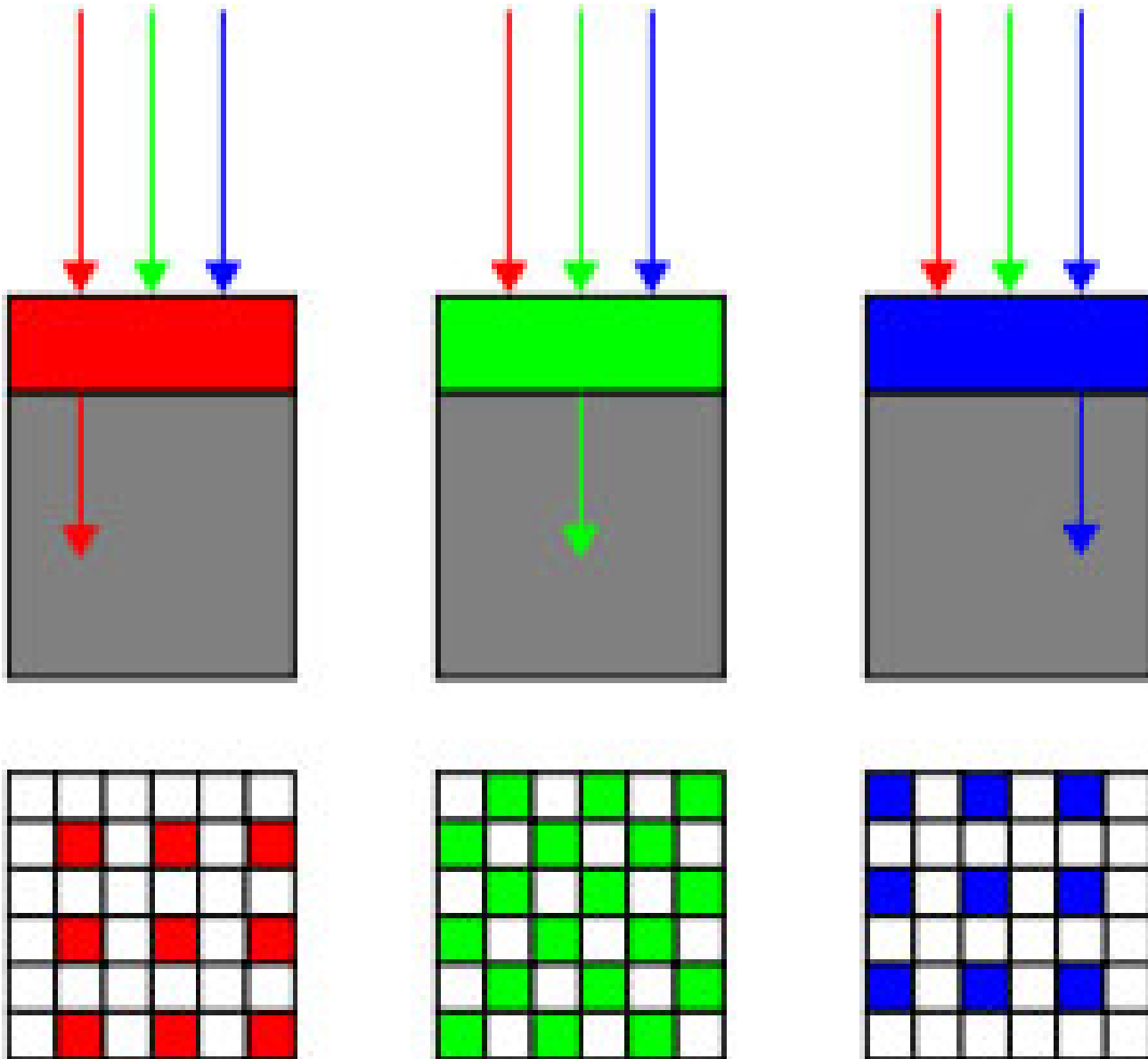

Alternative to Bayer

